

## NORDIC design\_gianluigi landoni

### 525



#### IT\_Descrizione prodotto

Poltrone, divani, divani componibili, terminali, chaise longue, pouf, contenitore, tavolo

#### Caratteristiche tecniche

**Struttura:** massello di abete e legno multistrato.

**Molleggio:** nastri elastici intrecciati.

**Imbottitura:** poliuretano espanso.

**Cuscini seduta:** poliuretano espanso a quote differenziate e memory ricoperto in termolegato cotone 100%.

**Cuscini schienale:** fibra poliestere siliconata ricoperta da fodera in cotone 100%.

**Piedi:** metallo verniciato.

**Rivestimento:** rivestimento in tessuto o in pelle. Rivestimento in tessuto completamente sfoderabile.

**Contenitore:** legno laccato nero.

**Tavolino:** legno laccato nero.

**Accessorio:** poggiatesta in tubolare di ferro verniciato con cuscino in fibra poliestere siliconata ricoperta da fodera in cotone 100%.

**Opzione:** alzata sovratavola in marmi diversi.

#### EN\_Description of the product

Armchair, sofas, unit sofas, end elements, chaise longue, ottoman, container, table

#### Technical features

**Frame:** solid fir-wood and multilayer.

**Springing:** elastic bands.

**Padding:** polyurethane foam.

**Seat cushions:** polyurethane foam with different densities and memory covered with heated bonded polyester fibre.

**Back cushions:** silicone polyester fibre covered with 100% cotton lining.

**Feet:** painted metal.

**Cover:** fabric or leather cover.

Fabric cover completely removable.

**Container:** black lacquered wood.

**Table:** black lacquered wood.

**Accessory:** headrest in lacquered iron tubes with cushion in silicone polyester fibre covered with 100% cotton lining.

**Option:** riser far table top in different marble types.

- A - Memory foam / Memory foam
- B - Espanso densità portante / Foam supporting density
- C - Espanso densità soft / Foam soft density
- L - Fusto in legno / Wooden frame
- R - Resinato / Heated bonded polyester fibre
- S - Fibra poliestere siliconata / Silicon polyester fibre

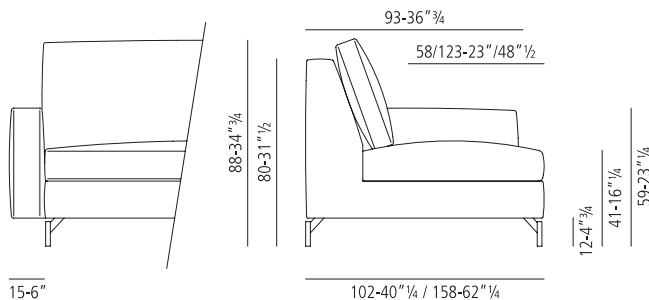
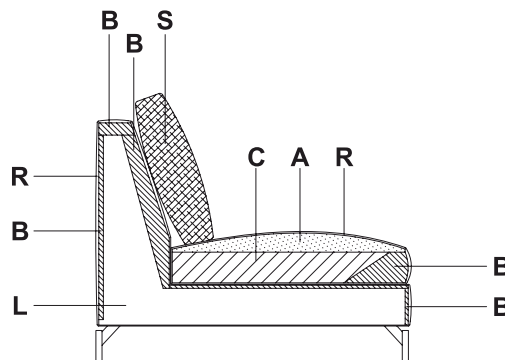

## 525

**\_ELEMENTI**  
**\_ELEMENTS**

\_cod 525000



\_cod 525001

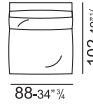

\_cod 525002



\_cod 525003



\_cod 525004

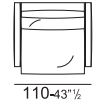

\_cod 525005

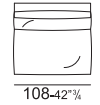

\_cod 525006

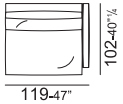

\_cod 525007

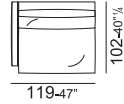

\_cod 525008

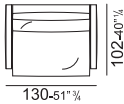

\_cod 525009

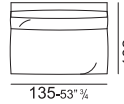

\_cod 525010

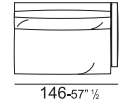

\_cod 525011

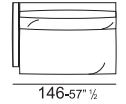

\_cod 525012

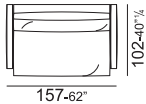

\_cod 525013

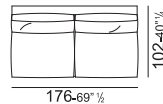

\_cod 525014

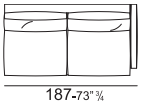

\_cod 525015

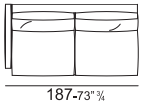

\_cod 525016

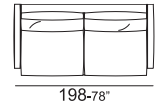

\_cod 525017

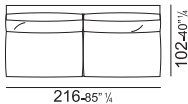

\_cod 525018

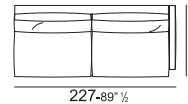

\_cod 525019

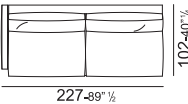

\_cod 525020

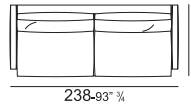

\_cod 525023

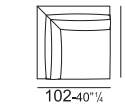

\_cod 525021

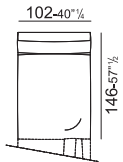

\_cod 525024

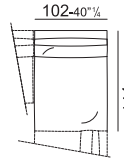

\_cod 525026

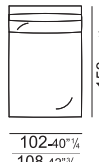

\_cod 525027

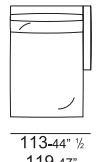

\_cod 525028

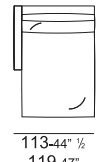

**\_POUF**  
**\_OTTOMAN**

\_cod 525029

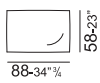

\_cod 525030



\_cod 525031



\_cod 525032

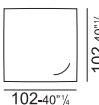

**\_VISTA LATERALE**  
**\_SIDE VIEW**

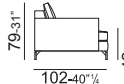

**\_TAVOLINI**  
**\_SMALL TABLES**

\_cod 525033

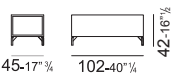

\_cod 525034

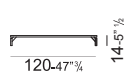

\_cod 525035

